

STONEGLASS[®]

A technical drawing grid consisting of solid and dashed lines forming a perspective grid. The grid is composed of vertical lines and horizontal lines that converge towards a vanishing point, creating a sense of depth and perspective. The text 'TECHNICAL MANUAL' is centered within this grid.

**TECHNICAL
MANUAL**



ATTENTION

The missed observance and implementation of rules of this manual will cause the revocation of any kind of warranty.



STONEGLASS disclaims any and all responsibility for damages caused to people and/or things deriving from incorrect installation and/or improper use of product, from its failure or neglected maintenance and in general from the non-observance of the warnings contained in this manual. These warnings are complementary to the general safety rules in effect in the country of installation.

INDEX

Description of product	2
Technical features	3
Handling	7
Advice for design	11
Advice for manufacture	12
Waterjet's parameters	13
Blade cutting	14
CNC cutting table	16
CNC parameters	17
Advice for manual labor	21
Adhesives	22
Handling and installation countertops	24
Precautions for use on countertops	28
Coverings and ventilated facades	29
Floors and claddings	31
Cleaning	40
Warranty	41
Comparison of the materials	42
Disclaimer	43
Certifications	44
Warranty coupon	47

DESCRIPTION OF PRODUCT

Stoneglass® is an environmentally friendly material made from natural elements. It's obtained through a process of melting and crystallization of silicon particles. The process is very similar to the natural condition of granite formation.

Stoneglass® has the smooth and reflective surface.

Stoneglass® has the following features:

- Visuals: polished or matt. His appearance is compact with uniform color, planar, with different thicknesses and sizes (EN 15285:2008);
- Touch: smooth obtained by cold grinding (EN 15285:2008);
- Without resins, solvents and glue;
- Doesn't freeze because without pore;
- It's difficult to scratch because it has a high resistance to abrasion
- It's stain resistant because it doesn't have a porosity on surface in order to keep solid or liquid sediments;
- Doesn't has physical alterations and doesn't changes the color even after prolonged exposure to UV rays;
- It can be processed with no risk for health;
- It's 100% recyclable.

STANDARD SIZES

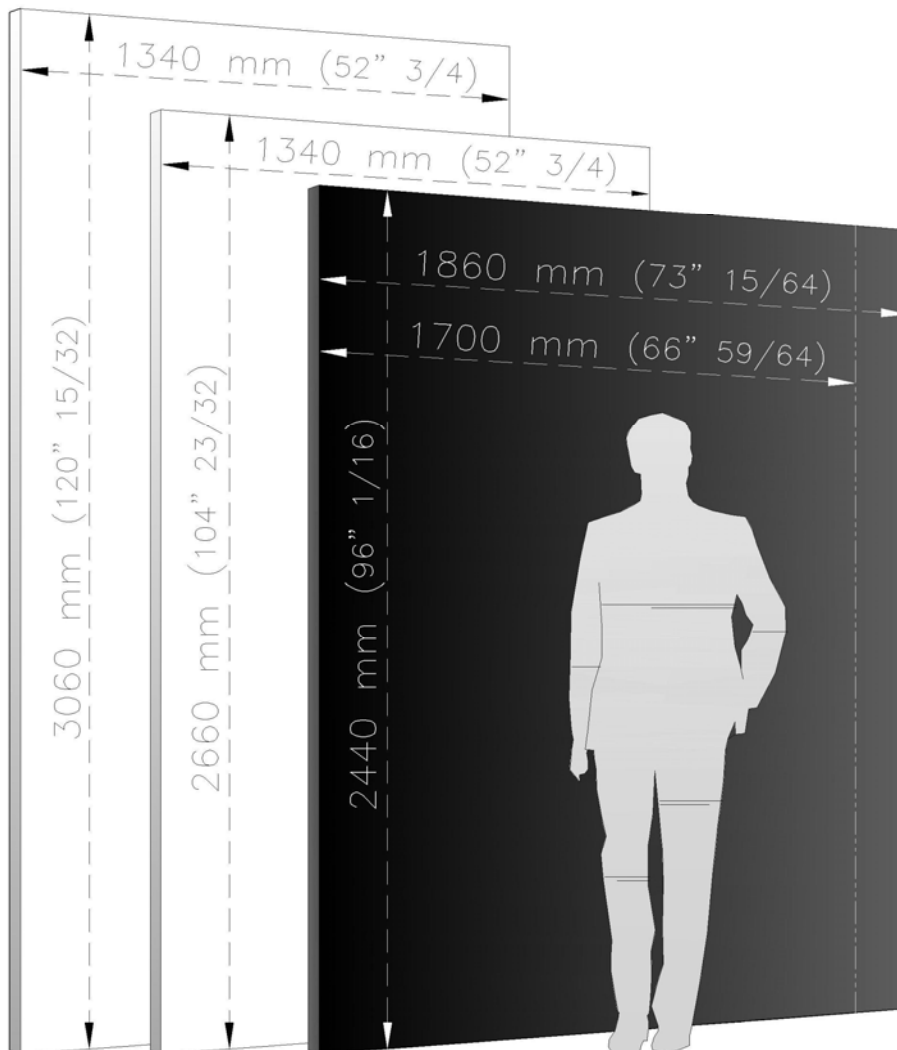

SPESSORI THICKNESS

BIANCO *WHITE*

12 mm
0" 15/32

18 mm
0" 45/64

30 mm
1" 3/16

NERO *BLACK*





15 mm
0" 19/32

18 mm
0" 45/64

TECHNICAL FEATURES

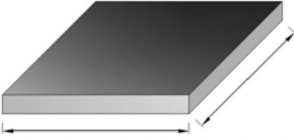

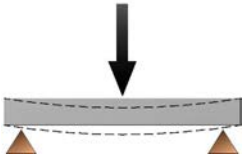
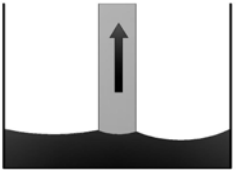
Regulation (EU) n.305/2011
 Harmonized standard UNI EN 15285:2008 dtd 24/07/2008
 “Agglomerated stone – modular tiles for flooring and stairs (internal and external)”
 UNI EN 15286:2013
 “Agglomerated stone – slabs and tiles for wall finishes (internal and external)
 Performance and characteristics ref. DoP

TECHNICAL FEATURES							
	Dimensions	<p>3060x1340 (10' 3/64 x 4' 25/64) 2660x1340 (8' 47/64 x 4' 25/64) 2440x1700 Black (8' x 5' 37/64) 2440x1860 Black (8' x 6' 1/32)</p>					
	Thicknesses	<p>12mm-18mm-30mm 0"15/32 - 0"45/64 - 1"3/16</p>					
	Flexural strength 14617- 2:2008	<table border="1"> <thead> <tr> <th>FLOORS/STAIRS INDOOR/OUTDOOR</th> <th>WALLS OUTDOOR</th> </tr> </thead> <tbody> <tr> <td>F3</td> <td>Rtf [MPa]=42,3</td> </tr> </tbody> </table>	FLOORS/STAIRS INDOOR/OUTDOOR	WALLS OUTDOOR	F3	Rtf [MPa]=42,3	
FLOORS/STAIRS INDOOR/OUTDOOR	WALLS OUTDOOR						
F3	Rtf [MPa]=42,3						
	Absorption EN 14617-1	<table border="1"> <thead> <tr> <th>FLOORS/STAIRS INDOOR/OUTDOOR</th> <th>WALLS OUTDOOR/INDOOR</th> </tr> </thead> <tbody> <tr> <td>W4</td> <td>0,003%</td> </tr> </tbody> </table>	FLOORS/STAIRS INDOOR/OUTDOOR	WALLS OUTDOOR/INDOOR	W4	0,003%	
FLOORS/STAIRS INDOOR/OUTDOOR	WALLS OUTDOOR/INDOOR						
W4	0,003%						
	Abrasion resistance EN 14157	A = 16.7mm					

TECHNICAL FEATURES

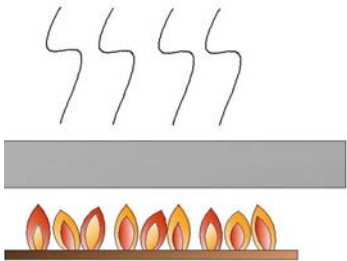
TECHNICAL FEATURES – FIRE REACTION			
	Fire classification EN 13501-1	FLOORS/STAIRS INDOOR/OUTDOOR	WALLS OUTDOOR/INDOOR
		A1/A1 FL	A1/A1 FL
	Reaction to fire testing on construction products – non combustibility indicative test EN ISO 1182:2005	-Average ΔT_f : 1,00°C -Average sustained flaming: 0,00 s -Average mass loss massa: 0 %	
	Reaction to fire tests for products – gross heat of combustion EN ISO 1716:2005	Product PCS: 0,0 MJ/Kg	
Determination of organic content	EN 13820:2004	Organic content: 0,0%	

TECHNICAL FEATURES

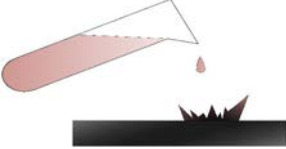
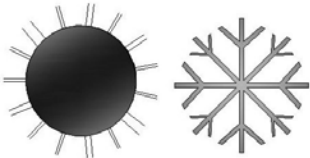
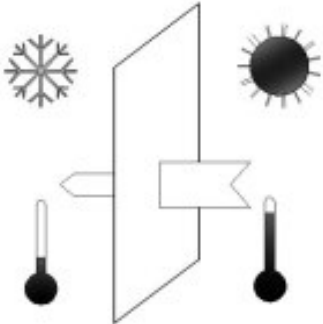
TECHNICAL FEATURES		
	<p>Dry heat resistance 180° time 20 minutes EN 13310:2004</p>	<p>No change</p>
	<p>Chemical resistance EN 14617-10</p>	<p>No stain or corrosion</p>
	<p>Determination of resistance to thermal shock EN 14617-6:2012 EN 14617-2:2008</p>	<ul style="list-style-type: none"> -Flexural strength Rsf [MPa] 39,2 -Weight change $\Delta m\% = 0,00\%$ -Flexural strength change $\Delta Rf, 20\% = 7,3\%$
	<p>Thermal conductivity and expanded uncertainty 12664:2002</p>	<p>1.38 +/- 0.12 W/(m*k)</p>
	<p>Thermal conductivity and thermal resistance by means of the guarded-hot-plate method $\Delta = 1/R$ EN 12664:2002</p>	<p>48,5 +/- 4,3 W/(m2*k)</p>

TECHNICAL FEATURES

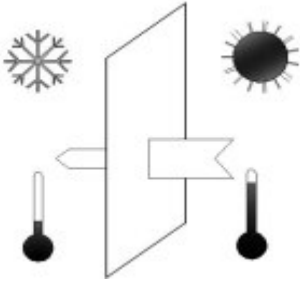
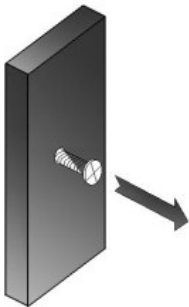
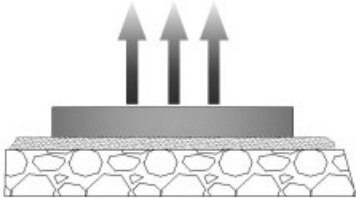
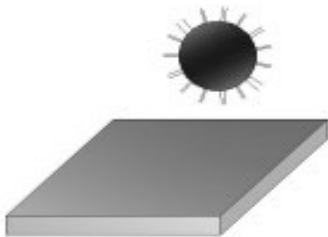
TECHNICAL FEATURES		
	<p>Thermal resistance "R" and relative expanded uncertainty</p>	<p>0,0206 +/- 0,0018 M2 * K/W</p>
	<p>Determination of resistance to fixing (dowel hole) EN 14617-8</p>	<p>2168 N</p>
	<p>Determination of tensile adhesion strength for cementitious adhesive – Initial adhesion strength</p>	<p>Adhesive strength "As" [N/mm²]=0,8</p>
	<p>UV resistance</p>	<p>No change</p>

For further certificates, see "Certificates list" on page 44.

HANDLING

PACKING

Wooden bundles: standard packaging for shipment on containers.

Wooden A-frame: additional cost at customer's charge for shipment by truck.

Non-standard packaging: for cut to size. The packaging may be crates or pallets: it depends on sizes.

The following info are indicative.

Technical info	U.M.	THICKNESS 12mm		THICKNESS 18mm		THICKNESS 30mm		BLACK THICKNESS	
								15mm	18mm
		2660x1340	3060x1340	2660x1340	3060x1340	2660x1340	3060x1340	2440x1700	2440x1860
Incoterm		EXW Stoneglass s.r.l.							
Slab surface	m ²	3,56	4,10	3,56	4,10	3,56	4,10	4,15	4,54
	ft ²	38,31	44,13	38,31	44,13	38,31	44,13	44,67	48,86
Slab weight	kg	106,8	123	160,2	184,5	267	307,5	155,6	204,30
	lb	233,86	271,16	352,78	405,76	588,63	676,92	341,84	449,80
Weight/sqm	kg	30		45		75		37,5	45
	lb	66,13		99,20		165,34		81,68	99,20
Slabs/bundle	nr.	23		17		11		14	10
Sqm/bundle	m ²	81,98	94,30	60,59	69,70	39,20	45,1	58,07	45,4
	ft ²	882,42	1015,03	652,18	750,24	421,94	485,45	625,06	488,68
Weight of wooden bundle	kg	70							
	lb	154,32							
Gross weight of bundle	kg	2530	2900	2796	3207	3010	3453	2248	2113
Maximum size of bundle	mm	3100 x 600 x 1500						2500x600x2090	
	ft	10' 11/64 x 1' 31/32 x 4' 59/64						8' 13/64 x 1' 31/32 x 6' 55/64	

The slabs of **Stoneglass®** are wrapped with embellished surface protected by a polyethylene film. The courier must safeguard the goods in the loading phases.

HANDLING



TRUCK

Payload: 14000 kg

Technical info	U.M.	THICKNESS 12mm	BLACK THICKNESS 15mm	BLACK THICKNESS 18mm	THICKNESS 18mm	THICKNESS 30mm
Total slabs	no	115	84	60	68	44
Gross weight	Kg	13760	13488	12678	12826	13810
	lb	30335,61	29735,95	27950,21	28276	30445,84
Total sqm	m ²	446,96	348,42	272,4	278,80	180,40
	ft ²	4811,03	3750,36	2932,08	3000,97	1941,80

LORRY

Payload: 24000 kg

Technical info	U.M.	THICKNESS 12mm	BLACK THICKNESS 15mm	BLACK THICKNESS 18mm	THICKNESS 18mm	THICKNESS 30mm
Total slabs	no	184	140	110	136	77
Gross weight	Kg	21700	22480	23243	24000	22830
	lb	47840,31	49599,92	51242,05	52910,95	50331,54
Total sqm	m ²	705	581	500	521	298
	ft ²	7588,55	6253,83	5381,95	5607,99	3207,64

HANDLING



CONTAINER 20' BOX

Payload: 27000 kg

Technical info	U.M.	THICKNESS 12mm	BLACK THICKNESS 15mm	BLACK THICKNESS 18mm	THICKNESS 18mm	THICKNESS 30mm
Total bundles	no	8	12	12	8	8
Total slabs	no	184	168	120	136	88
Gross weight	Kg	21700	26976	25356	24000	25900
	lb	47840,31	59471,90	55900,42	52910,95	57099,73
Total sqm	m ²	705	697	545	521	337
	ft ²	7588,55	7502,44	5866,33	5607,99	3627,43

When organizing a container should be considered the weight limit imposed by the port of destination.

The slabs during transport and storage shall be collected on suitable supports or structures like A-Frames or dedicated racks. These supports must be properly treated to avoid rust or any contamination of the material. It must also include appropriated protections to prevent any impact or abrasion during the transport, handling and storage of the material.

During storage, but in particular during the transport, you must use the wood to separate the packs of slabs. The material doesn't suffer the action of atmospheric agents and can be stored outside with careful to place it on a plastic, rubber or wooden base avoiding iron supports.

HANDLING

You should always handle the slabs with maximum care and attention in order to avoid the damage of material.

Here below appropriate precautions and recommendations.

The single slab can be moved through canvas belts covered with rubber, pincers covered with rubber or suckers.

Don't use chains or steel cables which may destroy the material.

For taking a single slab it is recommended to arrange the gripper in the middle of the load to balance the weight and to limit the oscillation .

Make sure that between the previous slab and the one that has just deposited there is no empty space

Attention: check always the maximum load capacity.

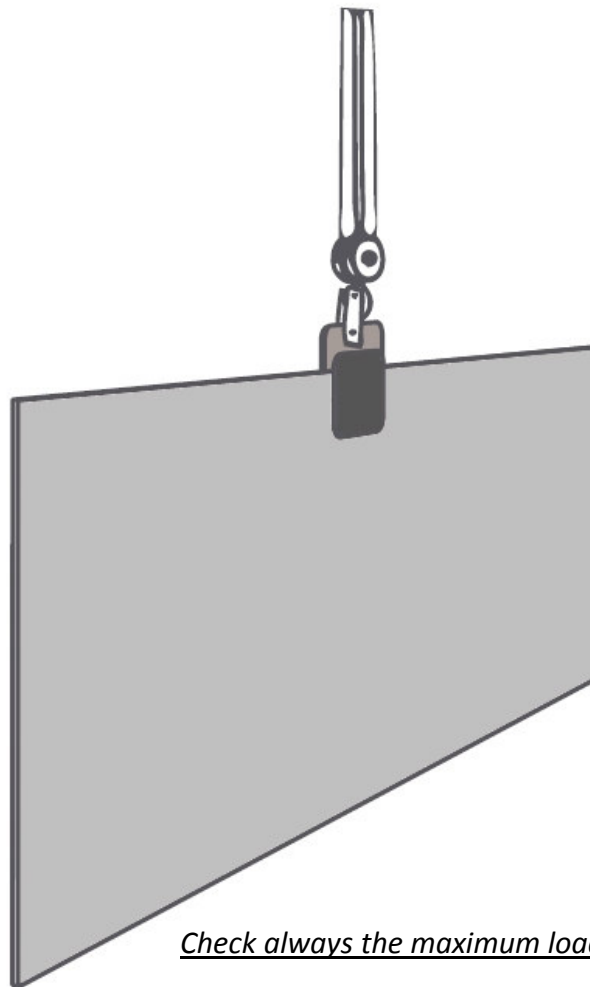

Check always the maximum load capacity

ADVISE FOR DESIGN

1. INNER CORNERS

All inner corners should have a minimum radius $\geq 5\text{mm}$.

A larger radius gives a greater structural strength, on the contrary, any corner without radius produces a stress point on the top

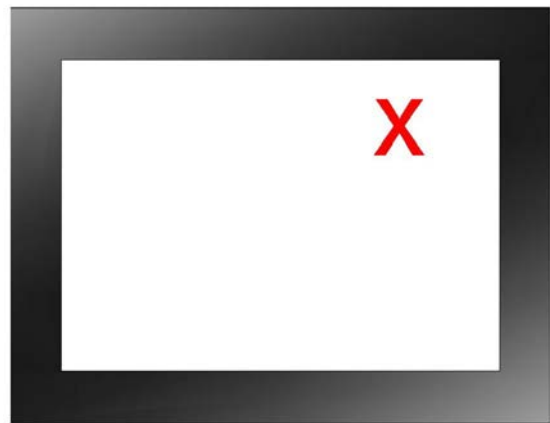
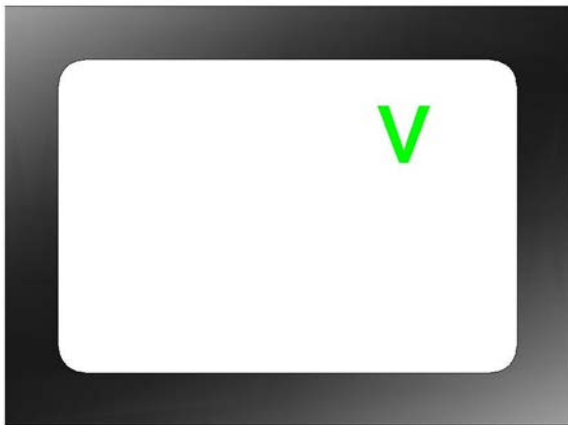

2. MINIMUM DISTANCE BETWEEN EDGES AND HOLES

The minimum recommended distance between edges of top and inner holes is 55mm.
The minimum distance between two inner holes is 60mm.



ADVISE FOR MANUFACTURE

One of features of **Stoneglass®**, is the easy workability. You can use the most common machines that are used for working glass and marbles.

Below some examples of cutting/finishing operations with related recommended parameters. **You must consider these parameters indicative because they may change on the basis of the machine and tools used.**

During all processing steps it's important that the **Stoneglass®** slab is always placed on a even surface or on calibrated sucker, this because any gap during the manufacturing process may create tensions that may cause breaking of the material

1. WATERJET CUTTING

We recommended to put the **Stoneglass®** slab over a polystyrene sheet in order to reduce any difference in level (thickness 2cm density 15/20).

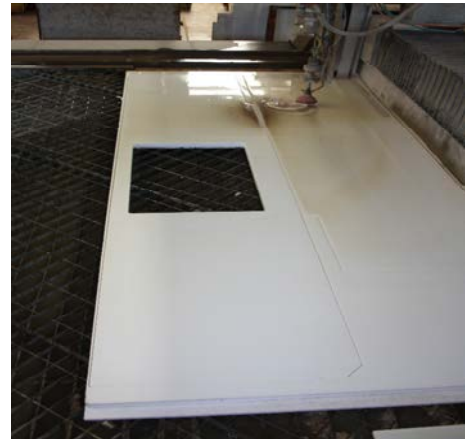
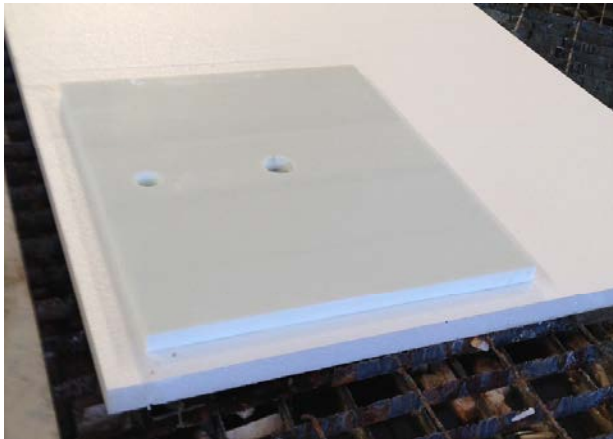

Do the entry hole outside respect the slab. In alternative make the hole a few centimeters from cutting perimeter and in any case, never less then 5mm. For inner holes, do always the input and output hole internally respect the part that you want to cut. Follow the below diagram (a low pressure for entry hole)

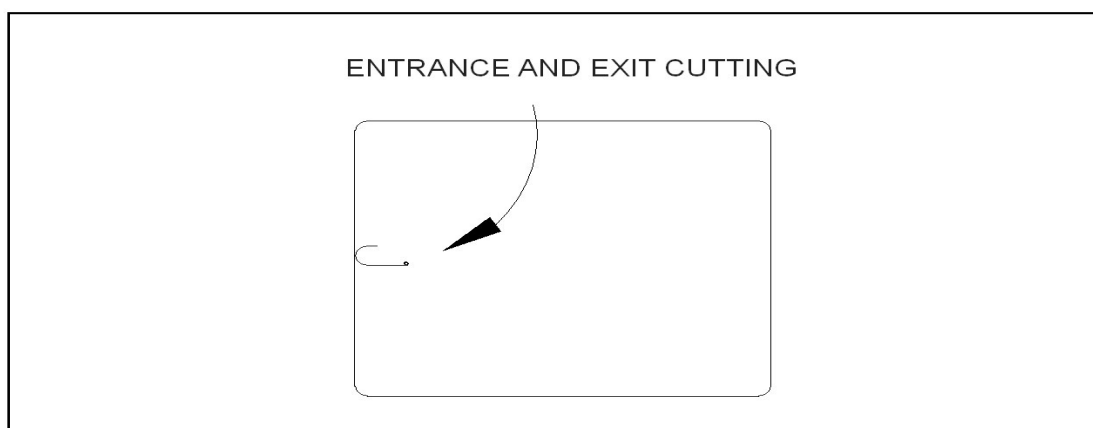

ADVISE FOR MANUFACTURE

WATERJET'S PARAMETERS

PARAMETERS OF INPUT HOLE WITH LOW PRESSURE

THICKNESS	MINIMUM PRESSURE Bar	MAXIMUM PRESSURE Psi
12-15-18-30	600	8700

PARAMETERS WITH HIGH PRESSURE

THICKNESS	MINIMUM PRESSURE DRILLING Bar / Psi	MINIMUM PRESSURE CUTTING Bar / Psi	PROGRESS mm/min	
			Inner perimeter	Outer perimeter
12	1200 / 17400	3800 / 55100	600	800
15/18	1200 / 17400	3800 / 55100	500	600
30	1200 / 17400	3800 / 55100	150	300

Those listed above are the recommended maximum value. To obtain a better finish, you must reduce the progress parameters.

Make sure your work surface is in good condition and flat; furthermore the piece must adhere perfectly to the plan without interference of waste or any other element of discontinuity.

For corners $\leq 90^\circ$ it's recommended to connect the area with a radius $\geq 5\text{mm}$.

ADVISE FOR MANUFACTURE

2. BLADE CUTTING

It's recommended to level the support's floor and to add under the **Stoneglass®** slab, a polystyrene sheet thick.20mm density 15/20 or in alternative a ground stone slab with thickness 2 cm. During the execution of the cut the blade has to sink into the underlying stone slab for at least 1 cm. In this way you avoid that the **Stoneglass®** slab suffers vibrations which may cause breakage.

For the execution of holes for sinks or hobs, it's recommended to make 4 holes (one for each corner) before proceeding with the cut both blade or end mill.

All profiles both internal or external must be properly shaped without chips or other flaws

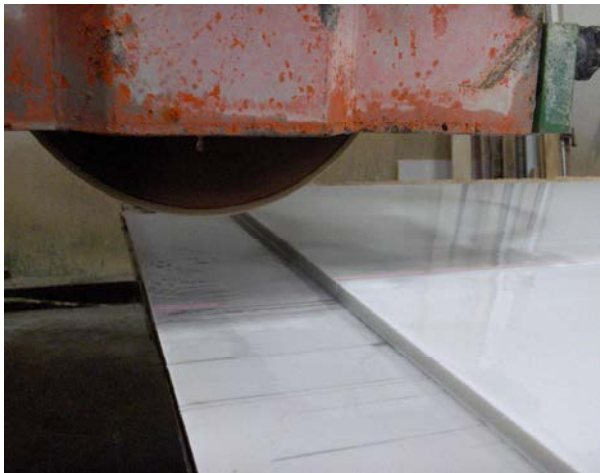

It's essential to use a suitable blade to cut **Stoneglass®** (see the picture).



Blade 1A1R Continuos
STONEGLASS® 400x2,6x10,0
Cod: 4074712
Hole: 60,0
Grain:D.151
RPM:1750

For a correct manufacture the cutting speed for thicknesses 12, 15 and 18 mm is 100cm/minute while for thickness 30 mm is 80cm/minute.

The cutting blade must protrudes at least 1 cm below the slab.

It's essential to lubricate the cutting with water.

It's recommended to revive the cutting blade with the special enlivened stone every 10/20 cuts.

ADVISE FOR MANUFACTURE

Make sure that the table of cutting milling is in good condition and flat.

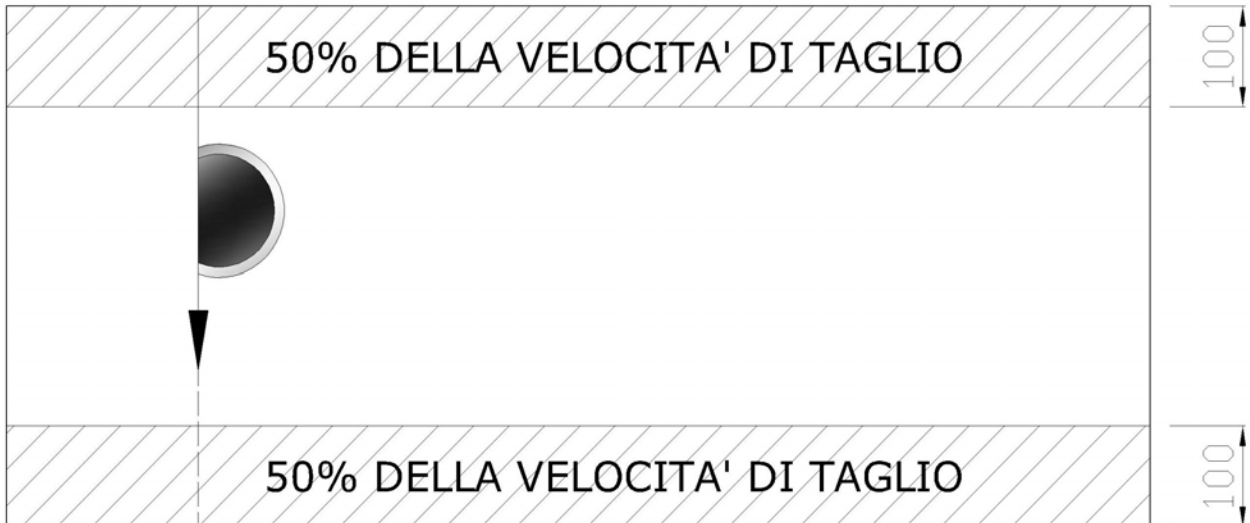

Slow down up to 50% of the incoming and outgoing progress for 100 mm speed.

It's recommended to place a piece of agglomerated of quartz or stone where disc goes out. This allows to limit the deviations of blade avoiding possible chipping.

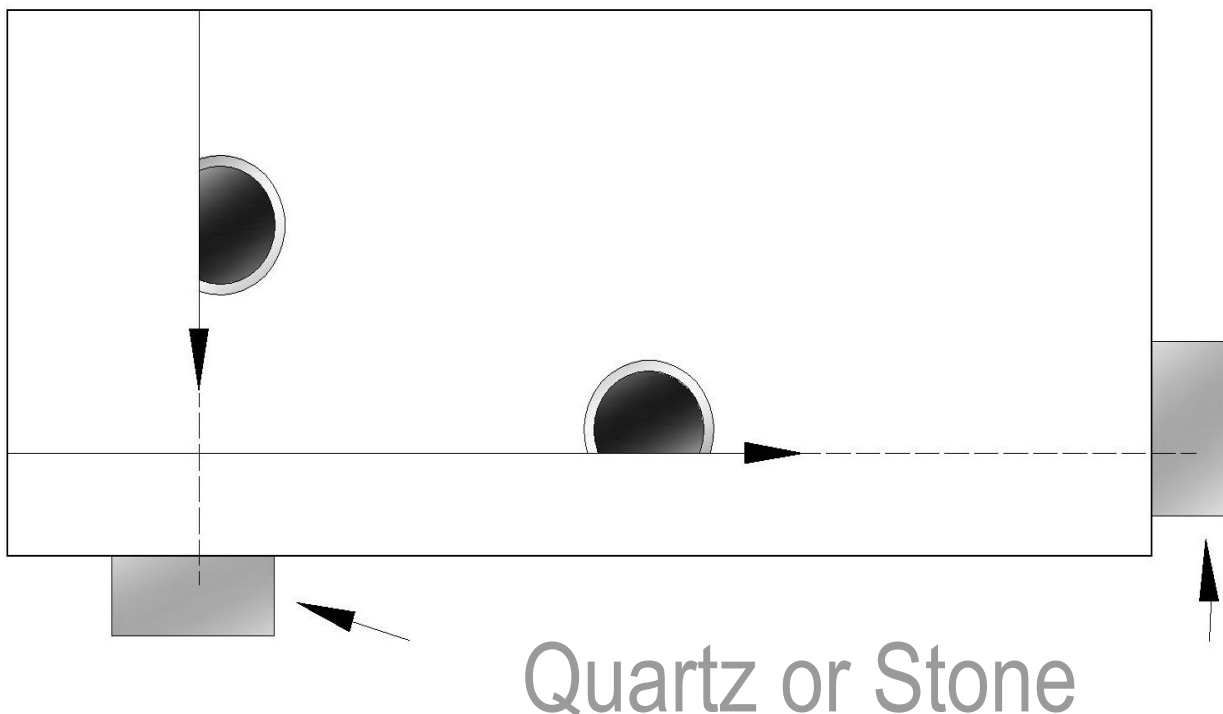

ADVISE FOR MANUFACTURE

3. CNC CUTTING TABLE

DIAMOND POINT	SPEED mm/min	CORNER OF TOOL	PRESSURE	PROGRESS
12	60000	155	3	12,5%
15/18	20000	155	9	12,5%

It's not recommended this kind of cutting for thickness 30mm.

Example CNC cutting table



ADVISE FOR MANUFACTURE

4. CNC PARAMETERS



DRILLING TOOLS Ø22mm

THICKNESS	PROGRESS	ARBOR ROUND g/min
12	40	2400
15/18	40	2400
30	40	2400

During the execution of the holes it's recommended before to lower the tool of 5mm and then move it up to 1 mm. In this way it avoids the potential tool overheating which can cause the breakage of the piece and/or of the tool.

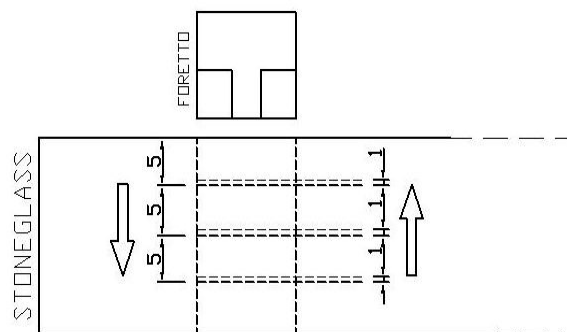

During processing it's recommended to use abundant well-directed water inside and outside of the tool.

To avoid chips on the back of the piece, we recommended to stop at 1 mm from bottom and to complete the drilling with delicate hammering on the opposite side.

Caution

After each process it's recommended to rinse the surface with clean water
We suggest to revive the tool with specific stone every 10 cuts.

ADVISE FOR MANUFACTURE



MILLING MACHINE Ø20mm

THICKNESS	PROGRESS	ARBOR ROUND g/min
12	400	11000
15/18	300	11000
30	200	11000

During processing it's recommended to use abundant well-directed water inside and outside of the tool.



Suggestions:

Any breakage is due to:

- a) too high speed of development
- b) far fewer laps than the rated speed of the tool
- c) insufficient cooling water

During the cutting phase if the material weighs on a single point could create breaks. Make sure that the worktop and the suckers are adjusted in order to don't have difference in height which may create stresses and breakages during the successive steps.

ADVISE FOR MANUFACTURE

GRINDING WHEEL FOR LOWERING



STONEGLASS®

THICKNESS	PROGRESS	ARBOR ROUND g/min
12	350	4000
15/18	350	4000
30	350	4000

Example:



ADVISE FOR MANUFACTURE



GRINDING WHEEL FOR
LOWERING
Flush top

THICKNESS	PROGRESS	ARBOR ROUND g/min
12	500	11000
15/18	500	11000
30	500	11000

Example:



Due to the normal use of the tools, the dimensional tolerance is +/- 2 mm respect to the technical performance data are to be considered normal. The allowed tolerance for thickness of the material is set at +/- 1 mm than the nominal size.

For further info, please watch the following video:

<http://youtu.be/XE-lGpSMEZ4>



ADVICE FOR MANUAL LABOR

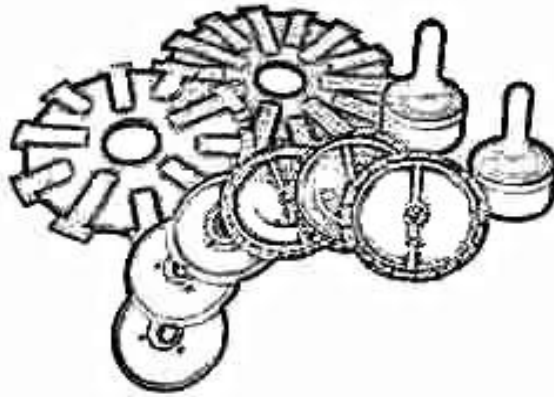

MANUAL LABOR

During any manual processing it's recommended to use a planar worktop in order to support the piece. Furthermore it's recommended to always use abundant water.

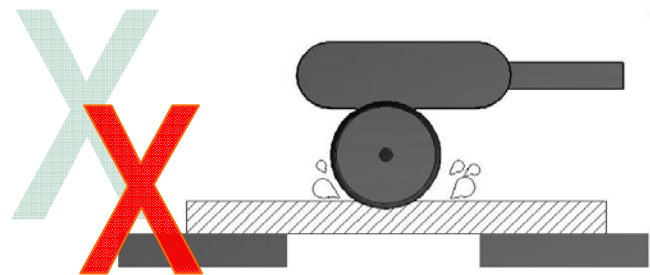
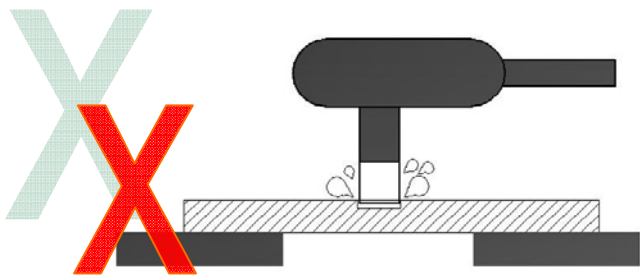
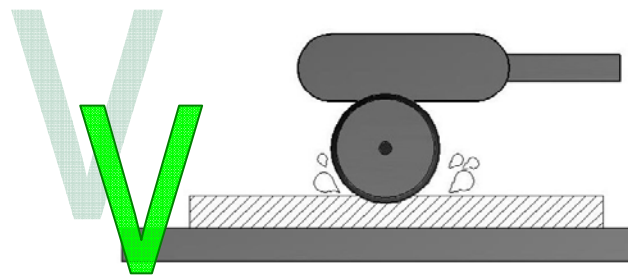
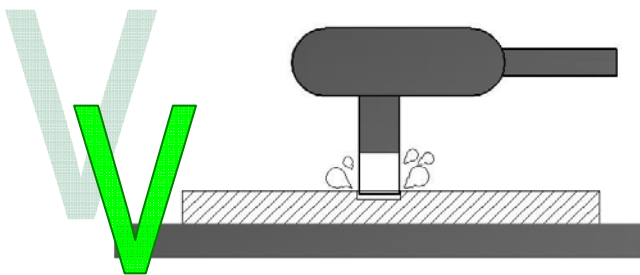

We suggest to revive the tool with specific stone every 10/15 cuts.

For further info, we invite you to watch the following videos:

https://youtu.be/7nuE0hQ_Ic0 (drill)

<http://youtu.be/AyleBDCT3NQ> (blade cutting)



ADHESIVES

PREPARATION OF SUPPORTS

Before applying the glue make sure that both surfaces are clean, well dry and free from any kind of treatment.

For gluing two 45° profiles we recommended you to don't finish the part to be bonded with polished wheels. The raw surface will ensure safe and durable bond. For more safety on the bonding at 45° it's a good norm to place a "L" profile mm 20x20 (about) on the back of the material (hidden) along the length of bonding of rise.

INTEGRA ADHESIVES

For gluing two 45° profiles that you want work later in order to have a rounded edge, we recommended to use an epoxy/methacrylate glue like, for example, the Integra Adhesive "Xi" which is ideal for joints, anchorings and angle's cuts.

This glue reduces the labor, eliminates the hand-mixing and it is created to produce invisible, resistant and quick-drying seams.

Available colors:

- Bianco/White [2420];
- Nero/Black [2080].



Appearance (Adhesive)	Clear or colored viscous liquid
Appearance (Activator)	Clear to white viscous liquid
Viscosity (Adhesive)	40,000 – 150,000 CPS
Viscosity (Activator)	20,000 – 25,000 CPS
Density	1.11 g/L
Working Time	10 – 15 minutes
Fixture Time	20 – 30 minutes
Recommended Bond Line	0.002 – 0.040 inches (0.5 – 1.0mm)
Flexural Bond Strength (to Solid Surface)	4000 – 6000 PSI (280-420 kb/cm ²)
Flexural Bond Strength (to Quartz)	3000 – 4000 PSI (210 – 281 kg/cm ²)
Shelf Life (Adhesive)	1 – 2 years
Shelf Life (Activator)	1 year
Mix Ratio (Adhesive : Activator)	10:1 optimum

ADHESIVES

PREPARATION OF SUPPORTS

Before applying the glue make sure that both surfaces are clean, well dry and free from any kind of treatment.

For gluing two 45° profiles we recommended you to don't finish the part to be bonded with polished wheels. The raw surface will ensure safe and durable bond. For more safety on the bonding at 45° it's a good norm to place a "L" profile mm 20x20 (about) on the back of the material (hidden) along the length of bonding of rise.

PATTEX SP101 WHITE

We recommended to use this product for the creation of all elastic bonding and to seal. Suitable for the construction works, joints, fastening of skirting, steps etc.

Once hardened the product, you can obtain an elastic bonding that offers excellent mechanical performance and an excellent adhesion.

You can use also to join two 45° profiles which don't require further manufacturing.



DATI TECNICI

Caratteristiche del prodotto prima della polimerizzazione

Base	Polimero flextec
Odore	Debolmente alcolico
Consistenza	Pasta tixotropica
Densità	ca. 1.37 g/ml
Perdita di tack	ca. 45 min
Tempo pelle	ca. 40 min.
Tempo di indurimento	2 – 3 mm/24 ore

Caratteristiche del prodotto polimerizzato

Odore	Privo di odore
Durezza Shore A	ca. 53
Modulo a 100% di allungamento	ca. 1,10 N/mm ² (ISO 8339)
Modulo a rottura	ca. 1,60 N/mm ² (ISO 8339)
Allungamento a rottura	ca. 300 % (ISO 8339)
Ritorno elastico	ca. 90 % (ISO 7389)
Temperatura di esercizio	-30°C a +90°C

HANDLING AND INSTALLATION OF COUNTERTOPS

Pay maximum attention during all phases of handling.

You must **ALWAYS** move it in the vertical direction (knife way) and **NEVER** horizontally.

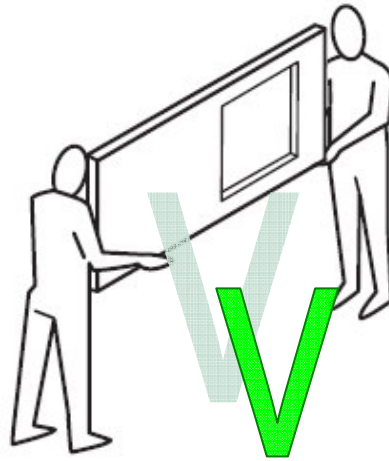
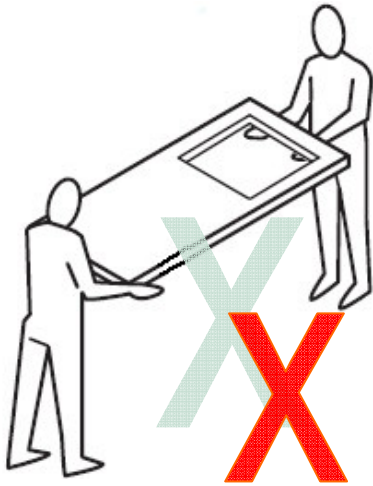

Keeping in vertical way the top:

- Remove the screws;
- Remove the wooden box;
- Place the top in a delicate manner in vertical way

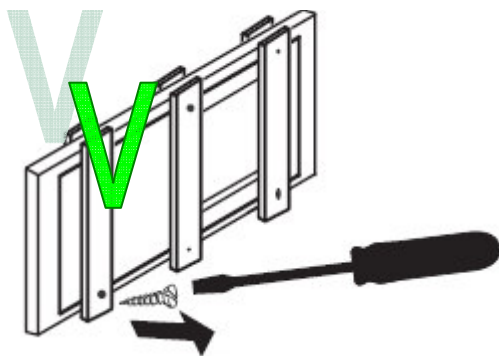
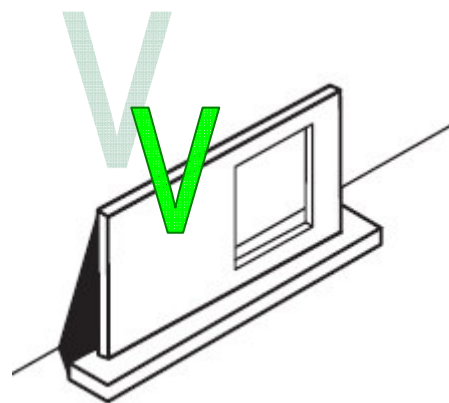
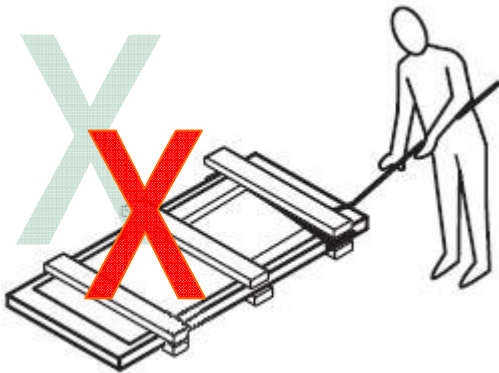

HANDLING AND INSTALLATION OF COUNTERTOPS

PLACEMENT WITHOUT WALL UNIT

In two or more people or with a suitable means of lifting, place the top in a delicate manner in vertical way and then push it against the wall.

In some points of perimeter put one or two drops of neutral silicone.

When you put down or pulling up the top in horizontally way be careful to don't burden the weight on one side but on whole length of the top.

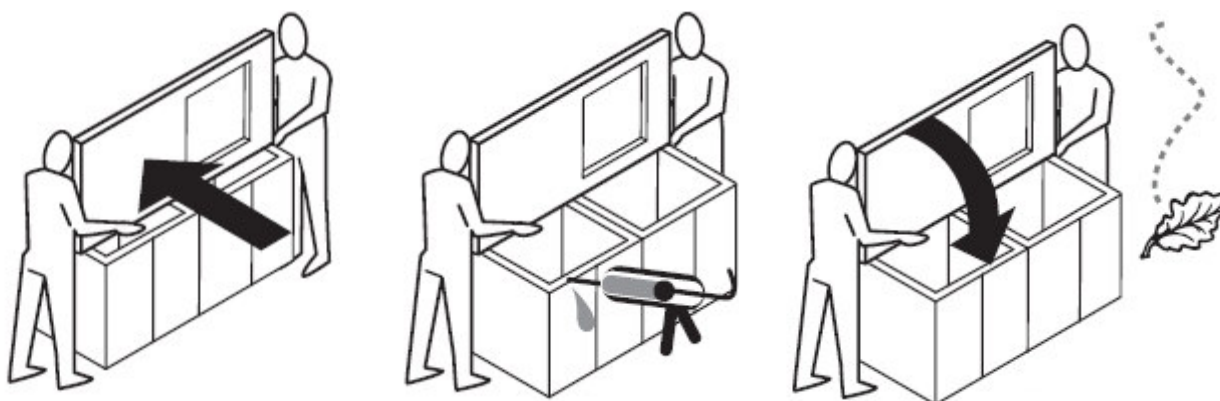

PLACEMENT WITH WALL UNIT

In two or more people or with a suitable means of lifting, be careful to don't damage the base. Place gently the top on the base and arrange it.

When you put down or pulling up the top in horizontally way be careful to don't burden the weight on one side but on whole length of the top

In some points of perimeter put one or two drops of neutral silicone and then place gently the top on the base.

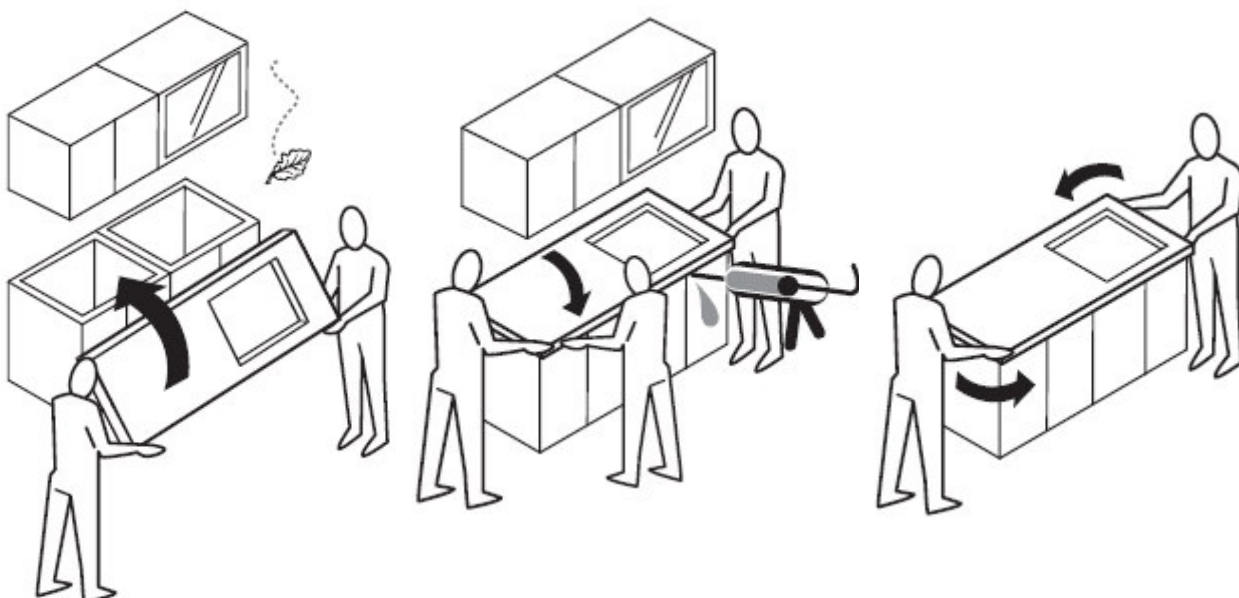

HANDLING AND INSTALLATION OF COUNTERTOPS

It's very important put the **Stoneglass®** top on a planar, level and structurally solid base. Most of the cracks during the phases of assembly and post-installation are attributable to an irregular or inadequate support.

STONEGLASS®

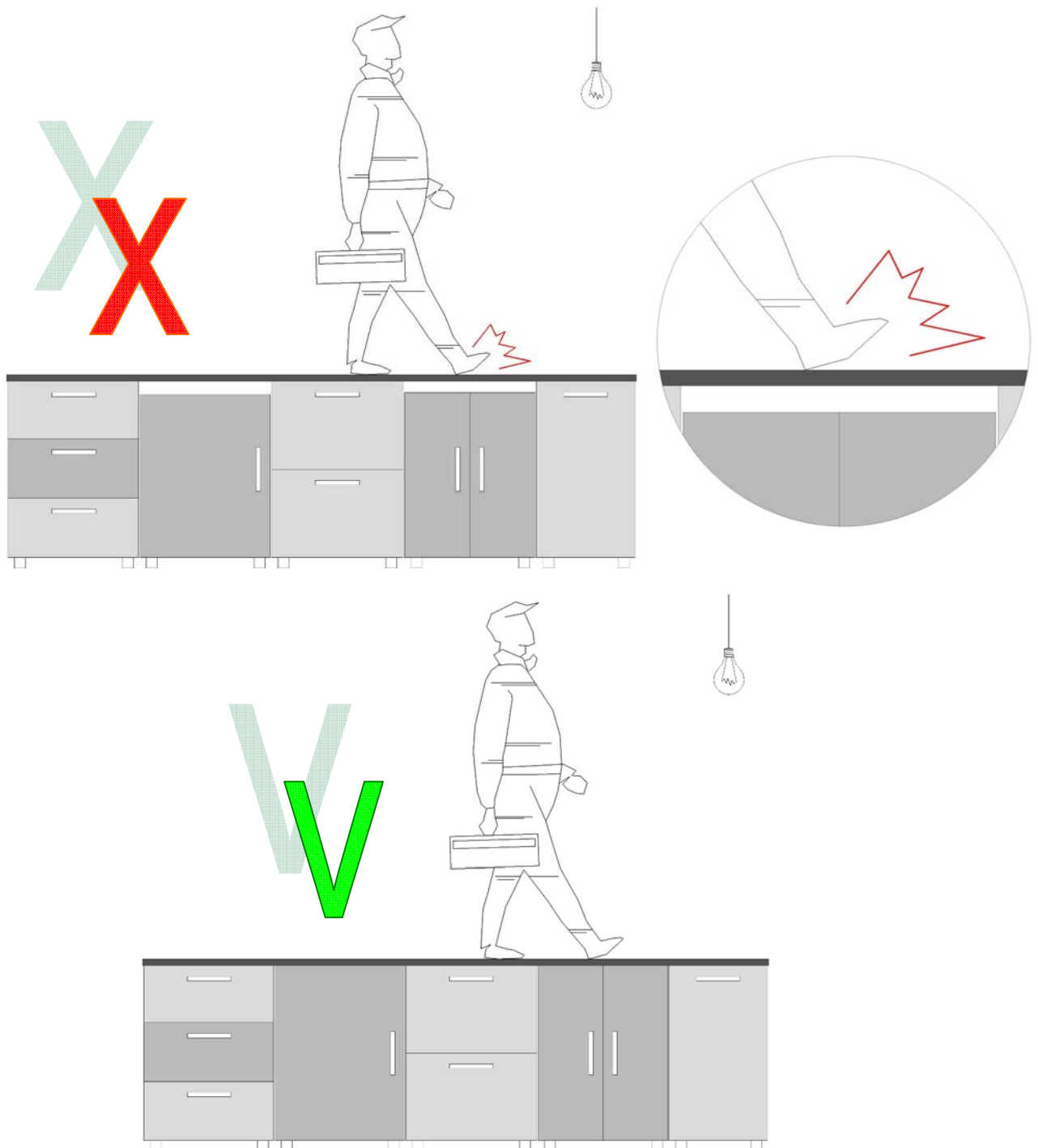

HANDLING AND INSTALLATION OF COUTERTOPS

PRECAUTIONS DURING THE ASSEMBLYING

- Don't bump or beat the **Stoneglass®** top with heavy objects.



- Don't leave work objects, cleanser, adhesive etc. on the surface: they may damage or stain the surface.

- Put gently in contact two tops to avoid shock that could shatter both.

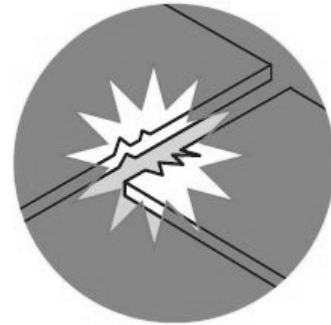

- Check for any difference between 2 or more tops. If necessary, level the tops using the adjustable feet of the bases and/or with the addition of the thicknesses.

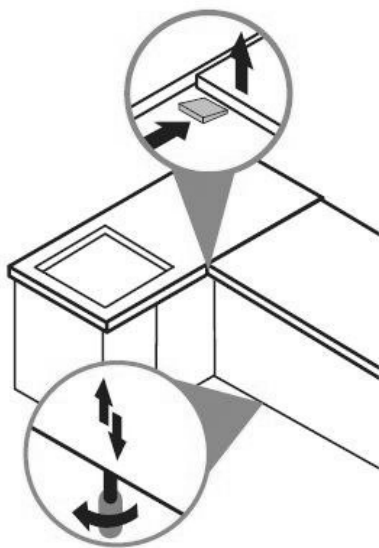

Don't over tighten the tie-rod, because in the course of time, may create cracks near the holes; both on appliance and on sink, especially if it is under top.

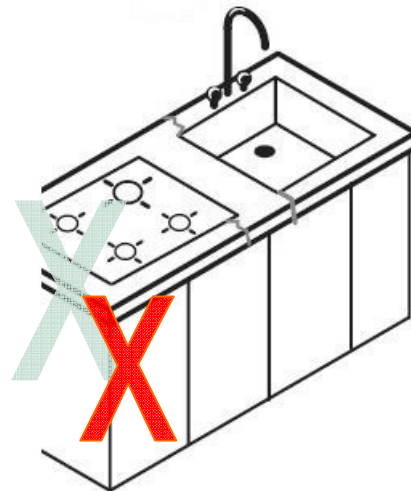

PRECAUTIONS FOR USE ON COUNTERTOPS

- Don't beat the meat or cut the food on surface directly. You must always protect the top with cutting boards or special countertops.

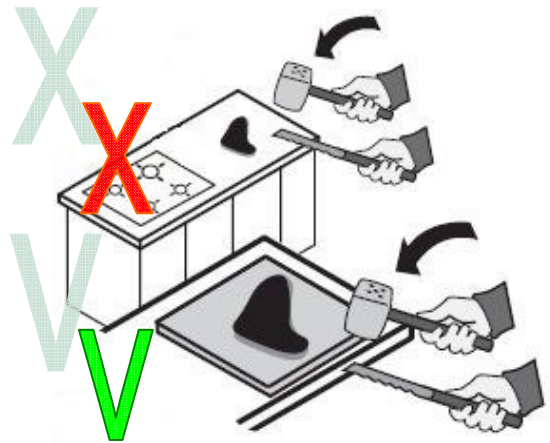

- Don't bump violently the countertop with heavy objects (bottles, glasses, dishes or pots) because it might chip.

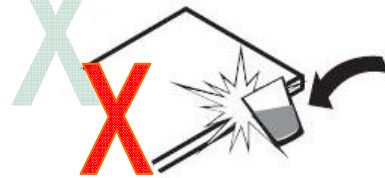

- Don't sit or climb on the countertop. Excessive weight (especially on large uncovered bases) can create cracks.

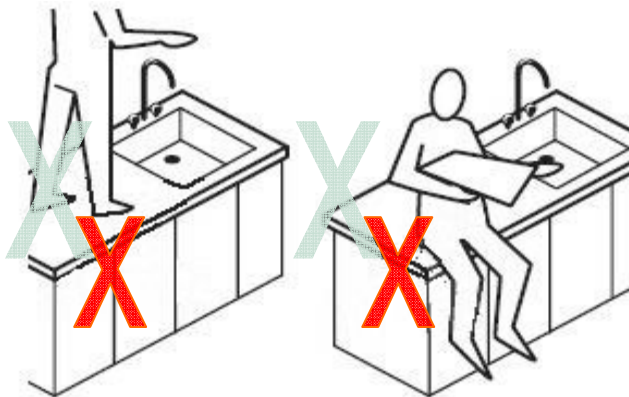

- Avoid direct contact with flames. **Stoneglass®** is heat resistant, however it's recommended to avoid direct open fire on **Stoneglass®** for a prolonged period because it can cause breakages.

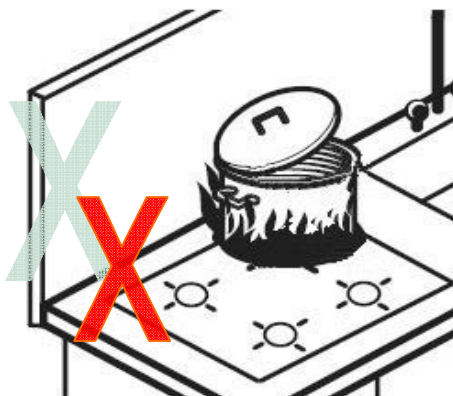

COVERINGS AND VENTILATED FACADES

The ventilated façade is a particular type of outside coating of the walls. It provides a dry application of suitable panels that are not strictly belonging to the structure. The ventilated façade has an outer coating layer which doesn't touch the hollow wall forming a gap.

In this way, we obtain the natural air circulation in the space between walls due to the convective motion produced by existence of openings at the base and at the top of the façade.

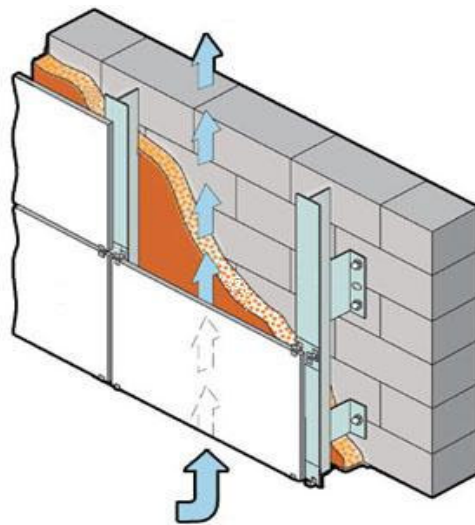

Stoneglass®, thanks to its technical/chemical characteristics and its high resistance to high temperatures, to frost and UV rays, is indicated for external applications as ventilated facades and floors.

For further info about certifications, see test from pag.3 to 6.

You can use the same fixing systems for ventilated facades that are commonly used also for other materials (marble, ceramics etc.)

You must choose the sizes and thicknesses against technical study by a professional firm that will evaluate the test results, the type of supports, the type of installation, the environmental conditions etc.



VENTILATED FACADES SYSTEMS

The fixing systems for ventilated facades that you can be used are those commonly used also for other materials as marble, ceramics etc.

You must choose the sizes and thicknesses against technical study by a professional firm that will evaluate the test results, the type of supports, the type of installation, the environmental conditions etc.

Here below some examples of systems tested on **Stoneglass®** (on demand, we can give also the result of test):

1. Fischer;
2. Keil;
3. Specialinsert.

1. **fischer** innovative solutions



For more info, visit the website <http://www.fischeritalia.it>

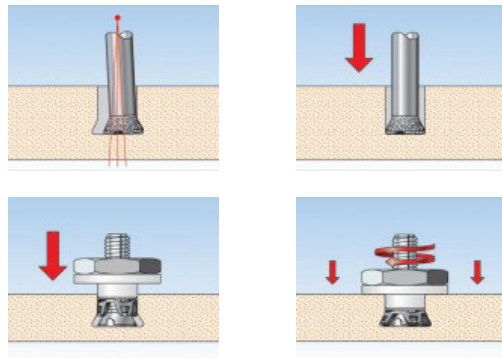

2. **KEIL**



For more info, visit the website <http://www.keil.eu>

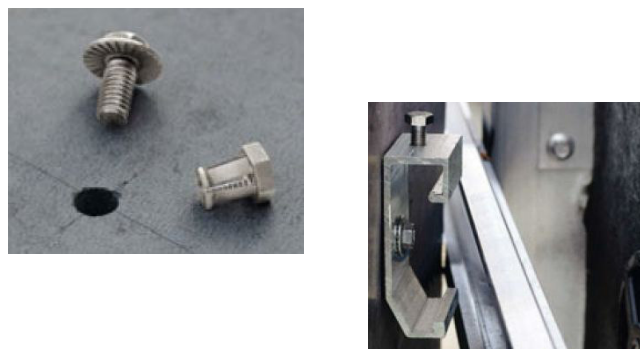

3. **Specialinsert**

For more info, visit the website <http://www.specialinsert.it>

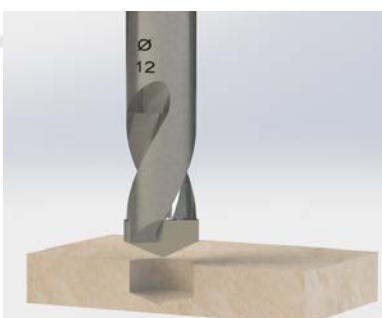

FLOORS AND CLADDINGS

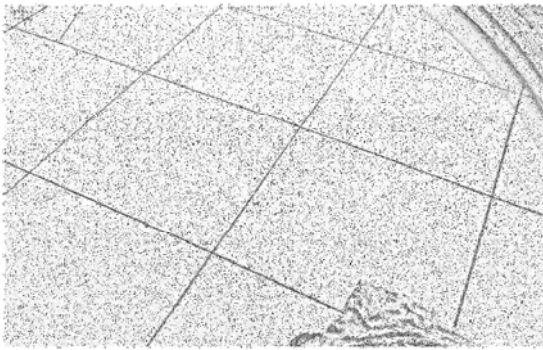

LAYING BY ADHESIVES

Thanks to the collaboration with  world leader in products for the construction industry, we have prepared some guidelines to hold in consideration for a perfect installation of **Stoneglass®**.

LAYING OF FLOORS AND COVERINGS IN INTERIOR

It is recommended to choose the size used according to the characteristics of the support on which to lay the **Stoneglass®** and according to the ability of the installers.

The supports on which to lay **Stoneglass®**, besides being suitable to withstand the expected stress, must be a plane surface, cleaned, seasoned and in any case adequate and suitable to act as a base for gluing with the bonding agent depending on the technical specifications of the same adhesive.

Some guidelines to follow are indicated in this document for the preparation of supports and laying of **Stoneglass®** coatings.

VERIFY THE SUBSTRATE

Before proceeding to the **Stoneglass®** laying it is necessary to make a thorough check of the supporting features. The verification criteria vary depending on the type of support on which you have to lay the installation.

SUBSTRATE IN CONCRETE

The supports will have to present clean, seasoned, dry and free from any substances which might affect following adhesions. The seasoning on a concrete slab can take several months and can vary considerably depending on the concrete mix, thickness, and environmental conditions.

Any cracks due to drying shrinkage of the support will have to be sealed by using a fluid two-component epoxy adhesive (type "Eporip" Mapei).

If the concrete support has a surface dusting, it is necessary to proceed to an adequate cleaning, followed by the application of suitable single-component primer based on acrylic resins in water dispersion with very low emission of volatile organic compounds - VOC (type "Primer g" or "Eco Prim T" of Mapei)

FLOORS AND CLADDINGS

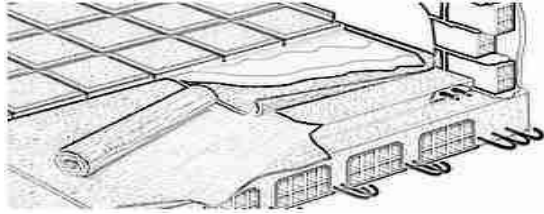

CEMENT SCREED

Basements you must be seasoned, clean, dry and free from any substance which might affect following adhesions.

The seasoning of a traditional cement basement takes about 7-10 days each centimetre of thickness. The drying may take a different timing depending on the water used to make the dough and environmental conditions. The timing can be conveniently reduced by using special mortars fast drying (type "Topcem Pronto" Mapei)

Any cracks due to drying shrinkage of the support will have to be sealed by using of bi-component fluid epoxy adhesive (type "Eporip" Mapei).

To reduce the risk of cracking in fresh basement, as soon as it has reached a consistency that does not cause the breaching of aggregates, it must be made of splitting joints for every about 20-25 m², in order to locally weaken the basement and concentrate any withdrawals, reducing the risk of formation of cracks distributed over the surface.

These joints must then be respected during the steps of laying.

When seasoned, the basement must present suitable mechanical resistance to the stresses to which the flooring will be subjected in operating conditions. In the case of residential floors are considered sufficient resistances of about 15MPa. In case of industrial or commercial floorings is considered that the compression strength of the basement must be ≥ 30 MPa.

DISCONNECTED SCREED

If it involves the construction of a disconnected screed is necessary to interpose between the substrate and the support (for example the finishing vault in reinforced concrete) a horizontal separating layer (for example a layer of polythene or PVC) and positioning along the perimeter of the walls around the pillars, a layer of compressible material, such as expanded polystyrene type, 1cm thick.

The sheets of sliding layer must be folded up to about 10 cm on the pillars and walls, overlapping them by at least 20cm and then taped. The thickness of this type of basement must be, in case of pedestrian traffic, not less than 35mm.

The disconnected screed (freed from the support), must have a minimum thickness of 4cm when installed in residential use with light traffic that may need to be increased with rising expected stress laid in operating conditions.

In cases where it needs to obtain a greater resistance to cracking and a better distribution of loads, insert in the centre line of the concrete slab during casting a electro-welded (galvanized wire mesh net).

The thickness should always be greater than 4cm if the basement is carried out on compressible layers, such as insulating materials. The increase of the thickness must be considered on the basis of the thickness and compressibility of the insulating layer. In this case it must always be provided for the insertion of an electro-welded mesh in the centre line of the basement.

FLOORS AND CLADDINGS

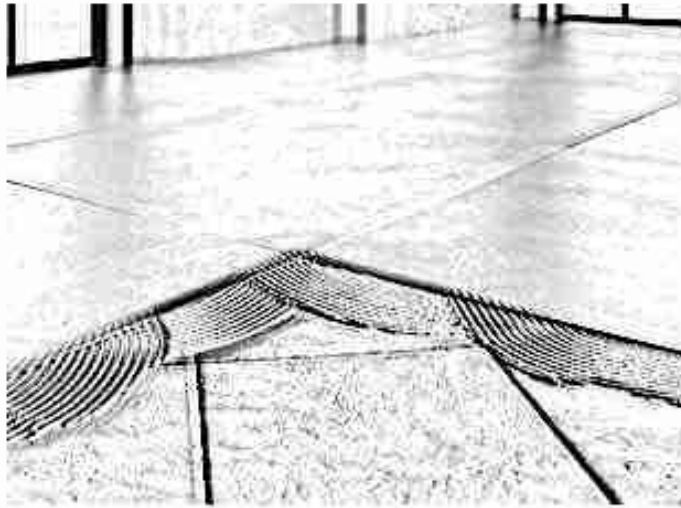

EXISTING FLOORING IN CERAMIC OR STONE MATERIAL

Generally the existing flooring of ceramic or stony material must be adequately cleaned by using a solution of hot water and caustic soda at 20%, and adequately rinsed with clean water to remove any traces of detaching substances. In some special cases it is possible to proceed to the superficial surface abrasion of the surface in order to create a rough and clean surface that favours following adhesions.

Such a preparation is required both before laying of the tiles and in the case of preventive application of levelling layers.

In the case of ceramic tiles and stony material, you must also ensure that the existing coating is perfectly bonded to the substrate, flat and free of cracks or portions which are detaching or flaking.

Otherwise it is necessary to:

- Remove all damaged tiles or those ones that ring empty;
- Seal any cracks on the substrate through the use of fluid two-component epoxy resins (type "EPORIP" Mapei);
- Fill the gaps created by removing the tiles or non-adherent plates, using levelling compounds, quick-hardening, thixotropic (type "PLANITOP FAST 330", "ADESILEX P4" or "NIVORAPID" Mapei);
- Fix any imperfections using flatness levelling mortars after adequate cleaning of the existing surface and eventual use of a suitable primer (Mapei type "ECOPRIM GRIP" or "ECO prim t").

To obtain a particularly regular laying plans you can use self-leveling (as ULTRAPLAN or ULTRAPLAN MAXI Mapei)

FLOORS AND CLADDINGS

PLASTER

It is recommended to choose the right size used according to the characteristics of the support on which to lay the **Stoneglass®** and according to the ability of the installers. The supports on which to lay the **Stoneglass®**, besides being suitable to withstand the expected stress, must be a plane surface, cleaned, seasoned and in any case adequate and suitable to act as a base for gluing with the bonding agent depending on the technical specifications of the same adhesive.

The following instructions and recommendations are appropriate:

CEMENT PLASTER

Before laying the substrates made of cement plaster must have the following characteristics:

- Seasoned (7-10 days per cm of thickness)
- Planar (level difference $< \pm 2$ mm, checked with a straight edge of 2 m)
- to have the adequate mechanical strength and well adherent to the substrate. The verification of this feature can be done by typing or by using specific tear tests.
- Dimensionally stable and therefore free from shrinkage and cracking problems
- Clean and devoid of any substance likely to affect following adhesions.

If the surfaces present surface dusting, it is recommended to apply a coat of the "primer g" or "Ecoprim t" (Mapei).

LAYING THE TILES IN INTERNAL

It is recommended to choose the format used according to the characteristics of the substrate on which to lay the **Stoneglass®** and according to the ability of the installers.

The following instructions and recommendations are appropriate:

Before proceeding with the laying of tiles **Stoneglass®** you must choose the most suitable adhesive depending on the type of support on which the installation is done, the target environment, the environmental conditions of the site and the time available between the laying and going into service or use.

For the laying of slabs **Stoneglass®** is usually recommended to use Elastorapid of Mapei.

In the case of special supports, such as metal substrates or non-absorbent, you must use reactive adhesives based on resins such as Ultrabond Eco can 2k of Mapei.

Carry out the appropriate verifications of the support described in the previous paragraphs, apply the tiles so that the adhesion is perfect and has a uniform flatness. In this purpose it is considered necessary to apply pressure to the tiles to facilitate the proper distribution of the adhesive.

Laying and grout must always be done with large space joint and, depending on the size of the tiles, the type of support and the operating conditions.

FLOORS AND CLADDINGS

COMMISSIONING OF FLOORING

Mix the adhesive and apply it on the substrate using a trowel whose teeth will be chosen depending on the size of the covering to be laid. The choice must be made so as to ensure total wetting of the back of the tiles. The tiles should be applied onto fresh within its open time, making sure that it has not formed a superficial skin; in that case it will have to be laid out a new fresh adhesive layer.

In the case of installation in public places with commercial destination, subject to heavy traffic, it may be necessary to proceed with the installation by the technique of double coating, or by applying the adhesive on the support and on the back of the slabs, so as to ensure a almost total wetting of the back of the slabs and minimize the risk of the presence of gaps on the back of the tiles.

Exerting a good pressure on the tiles to ensure adhesive transfer and make the necessary adjustments before the product comes into the grip.

The tiles must be laid by maintaining a minimum space of about 3-5 mm and creating approximately every 20-25 m² splitting joints, obviously respecting the joints that may be present on the support.



PLASTERING AND SEALING OF THE GROUT AND JOINTS

After hardening of the glue you can proceed with the plastering and sealing of floor joints.

You can proceed to plaster the joints using a two-component epoxy mortar as Kerapoxy CQ or Kerapoxy Design of Mapei. The sealing of splitting joints must be made with flexible sealant such as e-Mapesil LM of Mapei.

For further information, please view the video at the following link

<https://youtu.be/9UHZiE41mIQ>



FLOORS AND CLADDINGS

LAYING OF FLOORS AND COVERINGS IN EXTERNAL

SUBSTRATE PREPARATION

If the substrate has still to be realized it is recommended to realize a suitable waterproofing.

The screed in exterior must have a minimum thickness of 6 cm and a compression strength of at least 30 MPa. The minimum thickness, however, must be evaluated in accordance with the final destination and the expected loads.

To reach this strength value it is possible to use TOPCEM or TOPCEM PRONTO (classified CT-C30-F6-A1_{fl} in accordance with EN 13813). These products, used in compliance with their Technical Data Sheet, guarantee final performances (after 28 days) of 30 MPa of compression strength and 6 MPa of flexural strength.

The pre-packed mortar TOPCEM PRONTO, moreover, is certified EC1 R Plus in accordance to GEV Emericode and can be used to realize screeds with very low emissions of volatile organic compounds. As soon as the screed is solid enough it is necessary to cut it creating control joints each 15 m². Wider areas can be created if the screed has been realized using TOPCEM, TOPCEM PRONTO, MAPECEM o MAPECEM PRONTO.

The bonded screed must respect the joints present on the concrete slab.

When a traditional mortar is used to create the screed, the laying of **Stoneglass®** tiles will be possible after 7-10 days for each cm of thickness.

The use of TOPCEM or TOPCEM PRONTO allows to lay **Stoneglass®** tiles after 4 only days (residual moisture lower than 2%)

If a shorter time is required it is possible to use fast-setting mortars such as Mapei MAPECEM or MAPECEM PRONTO (classified CT-C60-F10-A1_{fl} in accordance with EN 13813).

PREPARATION OF EXISTING SUBSTRATES

When the laying of **Stoneglass®** tiles has to be realized onto existing substrates, it is necessary to verify its characteristics like compressive strength, flatness, cleanness, absence of cracks and of any kind of material that can compromise the adhesion of the materials that have to be used for the installation.

After an accurate clearing of the substrate, all the cracks present on the surface must be monolithically sealed using a two-component epoxy adhesive such as EPORIP Mapei.

All irregularities and holes on the substrate have to be filled with a suitable mortar applying in advance a slurry bond coat (the same suggested for bonding screeds).

To ensure a fast setting of the reparations the use of MAPECEM PRONTO Mapei is suggested, for thickness higher than 1cm. For thickness between 3 and 30 mm it is possible to use a fast-setting cementitious mortar such as PLANITOP FAST 330 Mapei without the necessity to apply a bonding slurry. The same products can also be used if it is necessary to create a slope.

Each time the substrate has irregularities higher than 3 mm, measured under a 2 m straight-edge, it will be always necessary the application of one of the above mentioned products to level the surface.

FLOORS AND CLADDINGS

LAYING OF TILES

After an accurate preparation of the substrate it is possible to proceed with the installation of **Stoneglass®** tiles.

CHOICE OF ADHESIVE

- **STONEGLASS TILES UP TO 60cm x 60cm**

Stoneglass® tiles can be laid using a normal setting, deformable, improved cementitious adhesive such as KERAFLEX MAXI S1 Mapei, classified C2TES1 in accordance with EN 12004. The laid flooring will be ready for light foot traffic after 24 hours and for the final use after 14 days. If a shorter installation time is required it is possible to use GRANIRAPID Mapei. GRANIRAPID is a fast setting, deformable, improved cementitious adhesive, classified C2FS1 in accordance with EN 12004. It is also certified EC1 Plus in accordance with GEV Emicode, with very low emissions of volatile organic compounds.

The laid flooring will be ready for light foot traffic after 3-4 hours and for the final use after 1 day.

- **STONEGLASS TILES BIGGER THAN 60cm x 60cm**

For the installation of big sized tiles it is possible to use ELASTORAPID Mapei. ELASTORAPID is a two component, fast setting, highly deformable, improved cementitious adhesive, with extended open time, classified C2TFES2 in accordance with EN 12004.

As an alternative it is possible to use ULTRALITE S2, one component, high-performance, highly deformable lightweight cementitious adhesive with a long open time and extremely high yield, easily trowellable with high back buttering properties, classified

The tiles must be laid respecting the joint realized on the screed.

Moreover it will be necessary to realize expansion joints in the flooring thickness. The jointed area dimension must be calculated in all the directions taking into consideration the direct sunlight exposure of the surfaces, and therefore the maximum thermal excursion expected, and the coefficient of thermal expansion of the material: $L = L_1 \cdot \alpha \cdot \Delta T$

(Dimension of the joint = length of the area side*coeff. of thermal expansion*max. variation of temperature).

CHOICE OF GROUTING

After the necessary time for grouting it is possible to grout **Stoneglass®** tiles using an high performance grout such as ULTRACOLOR PLUS Mapei, classified CG2 in accordance to EN 13888. This product, if correctly applied, ensure a fast setting, low water absorption and avoid the formation of efflorescence and moulds.

FLOORS AND CLADDINGS

CHOICE OF SEALANT

The joints of the screed have to be respected also on the final flooring and sealed with an elastic sealant like MAPESIL LM, neutral cross-linking silicone sealant. The same product has to be used to seal control joints on the flooring.

For the correct sizing of joints, and to avoid that the sealant adheres on the bottom of it, it will be necessary to put inside the joint MAPEFOAM Mapei, round closed cell expanded polyethylene foam cord.

SUBSTRATE PREPARATION

The installation onto external walls can contemplate different kinds of substrates.

CONCRETE

The installation on concrete walls can be carried on only after the curing time. This period can vary depending on the concrete mix, its thickness, the environmental conditions, etc. The substrate must have high mechanical strength, should not present problems of shrinkage and cracking.

The surfaces must be adequately cleaned from any traces of dirt, release oils or any other substances that can inhibit the adhesion of the tiles.

In presence of spacer coming out from the surface, it is necessary to cut them at least at 2 cm of depth, to clean them from rust, apply a protective mortar like MAPEFER or MAPEFER 1K Mapei, then to restore the removed concrete using a thixotropic cementitious mortar such as PLANITOP RASA & RIPARA or MAPEGROUT 430 Mapei.

Both these products can also be used to realize reparations on old concrete structures before the installation of the tiles.

Any cracks must be widen, cleaned and sealed using an epoxy, thixotropic adhesive like ADESILEX PG1 Mapei.

Superficial irregularities and unevenness can be restored using NIVOPLAN Mapei, mixed with PLANICRETE to improve its adhesion and final performances.

CEMENTITIOUS RENDER

In presence of existing renders it is necessary to verify it is solid, smooth, resistant, clean, free from flaking elements or other substances that can inhibit the adhesion. Old paintings or adhesive have to be completely removed. It's always recommended to carry on pull-out test to verify the adhesion of the render onto the substrate: usually the minimum required value is 1 N/mm².

When a new render has to be realized it is necessary to use a cement based mortar with an high adhesion to the substrate (>1 N/mm²) and good flexural strength (8 N/mm²).

A render that satisfy this requirements can be realized adding to the normal mortar a special latex like PLANICRETE Mapei, diluted 1:4 with water, or using a special leveling mortar such as NIVOPLAN Mapei, mixed with the same PLANICRETE (2 kg each bag of NIVOPLAN) and water.

The installation of tiles can be carried out when the render is completely cured and has completed all its possible shrinkage, after at least 7-10 days each cm of thickness.

FLOORS AND CLADDINGS

OTHER SUBSTRATES

All the different kinds of substrates have to be well cleaned, solid and resistant. If the existent substrate is dusty it will be necessary to realize a new reinforced plaster, directly fixed to the structure.

Old paintings or adhesives have to be completely removed.

LAYING OF TILES

After an accurate preparation of the substrate it is possible to proceed with the installation of STONEGLASS tiles.

CHOICE OF ADHESIVE

For external application on walls usually it is suggested a high deformable adhesive, due to the high possible solicitation of the covering.

Stoneglass® tiles can be laid using a normal setting, high deformable, improved cementitious adhesive such as KERABOND Mapei, mixed with ISOLASTIC instead than water just to reach the class C2ES2 in accordance with EN 12004.

If a shorter installation time is required it is possible to use ELASTORAPID Mapei. ELASTORAPID is a fast setting, highly deformable, improved cementitious adhesive, with extended open time, classified C2TFES2 in accordance with EN 12004.

Moreover it will be necessary to realize expansion joints. The jointed area dimension must be calculated in all the directions taking into consideration the direct sunlight exposure of the surfaces, and therefore the maximum thermal excursion expected, and the coefficient of thermal expansion of the material: $L = L_1 \cdot \alpha \cdot \Delta T$

Expansion joints must always be realized in correspondence of corners, edges, string courses, doors and windows.

CHOICE OF GROUTING

After the necessary time for grouting it is possible to grout **Stoneglass®** tiles using a high performance grout such as ULTRACOLOR PLUS Mapei, classified CG2 in accordance to EN 13888. This product, if correctly applied, ensure a fast setting, low water absorption and avoid the formation of efflorescence and moulds. It is also certified EC1 Plus in accordance with GEV Emicode, with very low emissions of volatile organic compounds

CHOICE OF SEALANT

The joints of the substrate and the expansion joints previously prepared have to be respected also on the final tiling and sealed with an elastic sealant like MAPESIL LM, neutral cross-linking silicone sealant.

For the correct sizing of joints, and to avoid that the sealant adheres on the bottom of it, it will be necessary to put inside the joint MAPEFOAM Mapei, round closed cell expanded polyethylene foam cord.

CLEANING

NORMAL MAINTENANCE

For the usual maintenance of **Stoneglass®** use a damp cloth or follow the below recommendations:

- For the superficial dirt, the common products for cleaning glass are enough;
- You can remove the stubborn dirt also in a later time using products to degrease and with anti-scaling agents;
- Avoid abrasive sponges, because not required;

In the event that you have crusted stains, let the cleanser on it and then remove it with a cloth. **Stoneglass®** doesn't absorb therefore it's easy to remove the crusts.

SPECIAL MAINTENANCE

For the extraordinary cleaning of ink stains, spots of paint or usually after that the use of normal products for washable surfaces were not effective in order to remove the stain, it can be used a mixture of industrial acetone (30%) and water (70%).

Products to be avoided for the maintenance of Stoneglass®:

- Products with basic ph;
- Trichlorethylene;
- Industrial solvents;
- Solvents for paint;
- Fluoric acid;
- Dichloromethane;
- Sodium hydroxide.

Note

At the end of life of your **STONEGLASS®** product, don't throw it out in the environment because **Stoneglass®** is recyclable therefore you can follow the same procedure of glass.

STAINING AGENT	VARIATION OF COLOR AFTER 1 HOUR	VARIATION OF COLOR AFTER 24 HOURS
Acetic acid (10% aqueous solution)	😊	😊
Acetone	😊	😊
Ammonia (10% aqueous solution)	😊	😊
Red wine	😊	😊
Cidric acid (10% aqueous solution)	😊	😊
Cleaning solution	😊	😊
Coffee 80° C	😊	😊
Cloramina T (2,5% aqueous solution)	😊	😊
Black permanent marker	some stains cleaned with acetone 😊	some stains cleaned with acetone 😊
Ethanol (48% aqueous solution)	😊	😊
Diethyl-butyl Acetate (1/1 V/V)	😊	😊
Olive oil	😊	😊
Coke	😊	😊
Na ₂ (CO) ₃ (10% aqueous solution)	😊	😊
NaCl (10% aqueous solution)	😊	😊
Tea 80°C	😊	😊
Milk	😊	😊
Condensed milk (9% fat)	😊	😊
Beer	😊	😊

WARRANTY

CONDITIONS

Art. 1 The Stoneglass S.r.l. in accordance with the values established by Legislative Decree n. 206 dtd 6.09.2005 (Codice del Consumo) and to all the rules in it, guarantees the quality of STONEGLASS® products for 12 years.

Art. 2 The product characterized by the STONEGLASS® brand appears in its essential characteristics such glass with silicon base.

Art. 3 For the distribution of STONEGLASS® product, the Stoneglass S.r.l. uses a network of distributors that provide the approved laboratories to transform the material as per sales network info (kitchen centers and official transformers indicated on the official website www.stoneglass.it) that has a direct relationship with the final users.

Art. 4 The final user is entitled to all guarantees forecasted on a.m. "Codice del Consumo" considering that STONEGLASS srl is committed to put on the market a safe product, as per previous art.2. Therefore, as producer, Stoneglass Srl accounts only defects pertinent with origin fault and/or structural as described on Title II of "Codice del Consumo". Therefore Stoneglass S.r.l. not account for any defect resulting from the transformation and processing of STONEGLASS® products. Even if the STONEGLASS® is not independently usable by the final user but it inevitably requires a transformation, we specify that there are no contraindications in order to prevent potential risks.

Art. 5 For defects related to quality of product as per previous point, STONEGLASS Srl gives to the final user a warranty for 12 years.

Art. 6 With this guarantee they are not covered those defects caused by successive phases of processing and installation, meaning with "processing" the shaping of the slabe and the relative polishing of the edges and meaning with "installation" the laying. Furthermore, this guarantee, as per art.117 of "Codice del Consumo", doesn't cover the improper or unsuitable uses or abuse of products such for example:

1. Improper or unsuitable uses, care and maintenance of the product in violation of instructions included in the Terms of Guarantee;
2. Thermal shock caused by exposure to direct heat;
3. Physical, chemical and mechanical abuses;
4. Improper preparation or maintenance of installation place;
5. Use of product under abnormal conditions or otherwise not in accordance with the technical quality on the bases of which it was designed.

Art. 7 In order to benefit the rights provided for by Guarantee, it is responsibility of the user of STONEGLASS® product:

1. Check, at the time of purchase, that the certificate of guarantee has been completed in all parts by the Official Transformer and by the Official Kitchen Center;
2. Send to Stoneglass S.r.l., at the above mentioned address, the completed and signed Guarantee coupon through registered mail within 7 days from date of purchase (indicate explicitly this date on certificate);
3. Denounce to Stoneglass S.r.l., within 15 days from discovery, the found defect by A/R post. With complaint send also: a copy of warranty certificate, copy of invoice (paid in full) or copy of the sales receipt.

Art. 8 The warranty is valid only if the Customer has respected the instructions indicated on this manual and only if the Customer has bought from Stoneglass Srl or by persons duly authorized by Stoneglass Srl.

Art. 9 The warranty go into effect on day when company Stoneglass Srl receives the enclosed warranty coupon. After a periodo of twelve years Stoneglass Srl doesn't give further guarantees.

Art. 10 If, during the validity of this guarantee, the Customer sells the product to third parties, in order to replace him in this warranty relationship, he must send to Stoneglass Srl his personal information and address within 7 days from purchase date. In this case Stoneglass Srl reserves the right to decide if subordinate this transfer the warranty after a verification of the product.





































Art. 11 The transfer of warranty from one customer to another one doesn't change the duration: the dies a quo starts as per previous art.8.

Art. 12 All disputes arising from notifications relating the quality of product, understood as a origin and/or structural fault in accordance with above mentioned art. 4, will be discussed in front of competent Judicial Authority where Stoneglass srl has the headquarter.

Art. 13 Stoneglass S.r.l. undertakes to respect the rules about privacy (d.lgs 196/2003 and successive modifications) using the personal data that will be sent through the enclosed coupon only for necessary purposes to the execution of this Guarantee and recognizes to holders of this info all rights of artt. da 7 a 10 parte I. titolo II del d.lgs 196/2003.

COMPARISON OF THE MATERIALS

STONEGLASS

	MARBLE	QUARTZ	STONEGLASS®
Thermal expansion			
Abrasion			
Stain resistance			
Heat resistance			
Frost resistance			
Absorption			
UV resistance			
Environmental impact			
Warranty			
Hygiene			
Ageing resistance			
Recyclability			

DISCLAIMER



DISCLAIMER

We produced this manual to provide guidelines and give useful suggestions for processing, installation and maintenance of **Stoneglass®** slabs.

The information here enclosed reproduce the actual art of technical-scientific knowledge and know-how of the manufacturer. You are therefore advised to refer to the most current version that is always available on website www.stoneglass.it.

In order to have a very good result, the customer must not to be limited to information provided in this document. He must use the ample technical and scientific literature available and to rely on the professionals all processing and installation phases.

Due to all the above mentioned, Stoneglass s.r.l. is not responsible for any damage that could happen in the application of information/suggestions contained in this technical manual because here you can find only information/suggestions that should always be verified by the user in advance.

The Stoneglass s.r.l. reserves the right to bring about technical changes without prior notice and without direct communication. We invite, therefore, to refer to the current updated version of "Technical Manual" available on website www.stoneglass.it.

Should check for any transport damage at delivery time of the material because we will be not accepted complaints of laid material with defects already existing at the time of delivery.

CERTIFICATIONS OF STONEGLASS®

PERFORMANCE IN RELATION TO **UNI EN 15285:2008** DTD 24/07/2008
APP. ZA.1.1 FLOORS AND STAIRS (INDOOR)

UNI EN 14617-1:2013	dtd 05/16/2013	apparent density
UNI EN 15285:2008	dtd 07/24/2008	water absorption
UNI EN 14617-2:2008	dtd 10/23/2008	flexural strenght
UNI EN 13501-1:2009		fire classification
UNI EN ISO 11802:2005		reaction to fire
UNI EN 13820:2004		organic content
UNI EN ISO 1716:2005		gross heat of combustion (calorific value)
UNI EN 15285:2008		look (visual)
UNI EN 15285:2008		look (touch)
UNI EN 12664:2002		thermal conductivity and expanded uncertainty
UNI EN 12664:2002		thermal resistance

PERFORMANCE IN RELATION TO **UNI EN 15285:2008** DTD 24/07/2008
APP. ZA.1.2 FLOORS AND STAIRS (OUTDOOR)

UNI EN 14617-2:2008	dtd 10/23/2008	flexural strenght
UNI EN 15285:2008		look (visual)
UNI EN 15285:2008		look (touch)
UNI EN 14617-6:2012	dtd 06/07/2012	thermal shock resistance
UNI EN 14617-2:2008	dtd 10/23/2008	flexural strenght

PERFORMANCE IN RELATION TO **UNI EN 15286:2013**
ZA.1.1 SLABS AND TILES FOR WALLS (INDOOR)

UNI EN 13501-1:2009		fire classification
UNI EN ISO 1182:2005		reaction to fire
UNI EN 13820:2004		organic content
UNI EN ISO 1716:2005		gross heat of combustion (calorific value)
UNI EN 14617-1:2013	dtd 05/16/2013	apparent density and water absorption
UNI EN 12664:2002		thermal conductivity and expanded uncertainty
UNI EN 12664:2002		thermal conductivity and thermal resistance
UNI EN 12664:2002		thermal resistance "R"
UNI EN 12004:2012	dtd 07/12/2012	adhesives for tiles (conformity)
UNI EN 1348:2008	dtd 05/28/2008	determination of tensile adhesion strenght
UNI EN 14617-8		resistance to fixing (dowel hole)

PERFORMANCE IN RELATION TO **UNI EN 15286:2013**
ZA.1.2 SLABS AND TILES FOR WALLS (OUTDOOR)

UNI EN 13501-1:2009		fire classification
UNI EN ISO 1182:2005		reaction to fire
UNI EN 13820:2004		organic content
UNI EN ISO 1716:2005		gross heat of combustion (calorific value)
UNI EN 14617-2:2008	dtd 10/23/2008	flexural strenght
UNI EN 14617-1:2013	dtd 05/16/2013	apparent density and water absorption
UNI EN 12664:2002		thermal conductivity
UNI EN 12664:2002		thermal conductivity and thermal resistance
UNI EN 12664:2002		thermal resistance "R"
UNI EN 14617-6:2012	dtd 06/07/2012	thermal shock resistance
UNI EN 12004:2012	dtd 07/12/2012	adhesives for tiles (conformity)
UNI EN 1348:2008	dtd 05/28/2008	determination of tensile adhesion strenght
UNI EN 14617-8		resistance to fixing (dowel hole)
UNI EN 13310:2004		dry heat resistance
UNI EN 12371:2003		freeze/thaw resistance (48 cycles)- compressive st.
UNI EN 12371:2003		freeze/thaw resistance (48 cycles)- flexural st.
UNI EN 1936:2001		determination of apparent density and open porosity
UNI EN 12371:2003		freeze/thaw resistance (12 cycles)- flexural st.
UNI EN 101:1992		Mohs
UNI 14617-11:2005		coefficient of linear thermal expansion
UNI 9104:1996		UV resistance



WARRANTY of PRODUCT

Dear customer, in order to take advantage of rights forecast with product's warranty, send through registered mail to Stoneglass srl this coupon duly completed and signed within 7 days from date of purchase.

Address:
Stoneglass s.r.l.
Via del Commercio Nord 83/85,
56034 - Casciana Terme (PI)
Tel. +39 0587 645079

How did you met STONEGLASS?

- Advertising in the specialised magazines
 Internet
 Suggested by the official Kitchen center

Why did you choose STONEGLASS?

- You like it aesthetically
 For its technical features
 For the warranty of 12 years

In your opinion, what is the level of received service?

Rating from 1 to 10 _____



Underwriting warranty form

Code or name of product:

Invoice:

Date _____

Number _____

Stamp of official Kitchen center:

Official transformer:

First name _____

Second name _____

Address _____

Zip code _____

City _____

Phone/Mobile _____

E-mail _____

Date of purchase _____

Signature for approval of warranty _____

All fields are required to make the guarantee valid





STONEGLASS[®]

Via del Commercio Nord 83/85
56035 Casciana Terme (PI) Italy
www.stoneglass.it
info@stoneglass.it